

【型紙の使い方】

縮小・拡大などせずにA4サイズの紙に必ず「100%」で印刷しましょう。

PDFデータの1ページ目に10cmの定規が印刷されていますので、実寸で印刷されているか必ず確認しましょう。

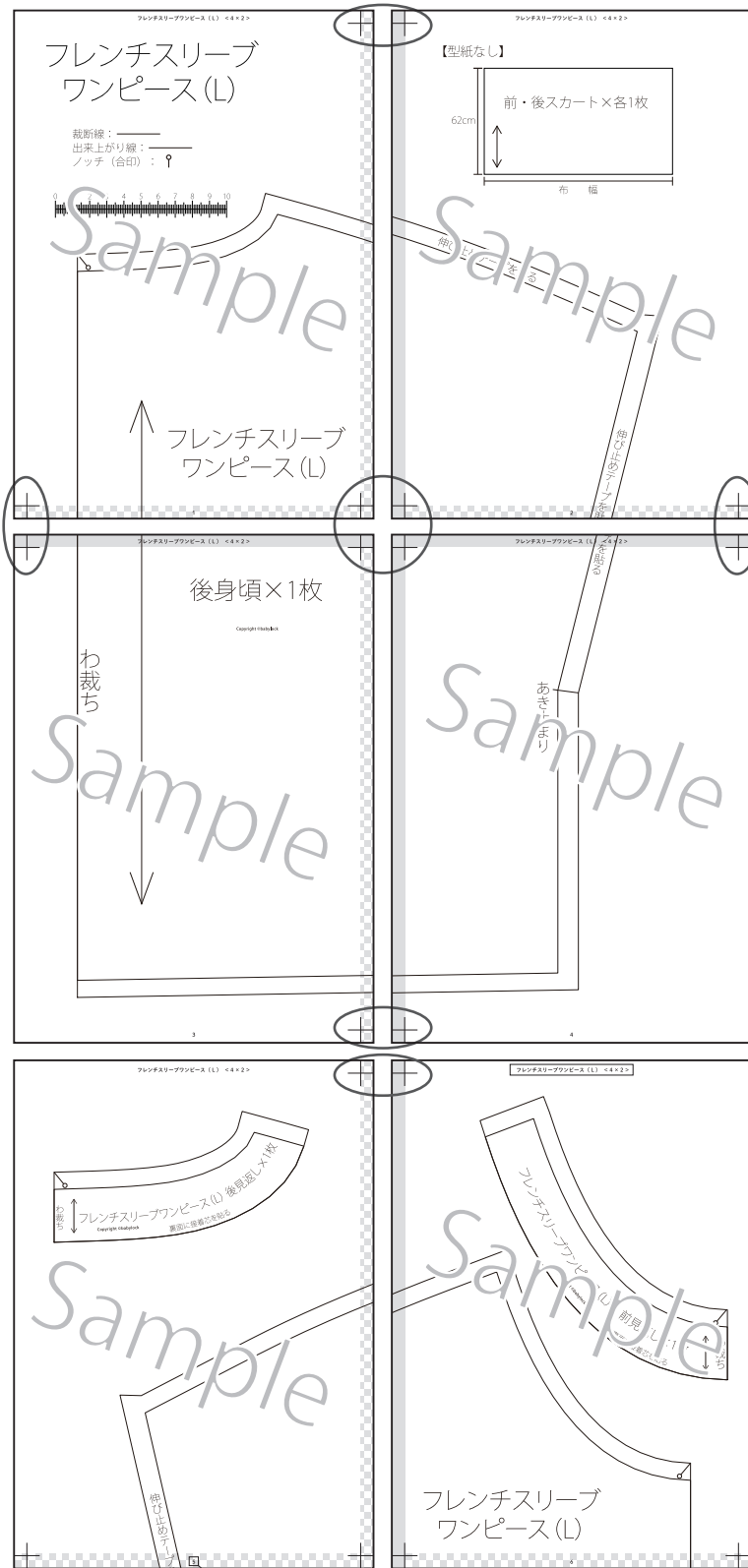



























5
ページ番号

◆パターンのつなぎ(貼り)方

- 1、図を参考に余白部分をカットし、角の印を合わせて貼り合わせる。
- 2、裁断線でカットする。

 のりしろ

 余白 (重なると線が見えなくなるのでカットすると良い)



↑

↑

↑

↑

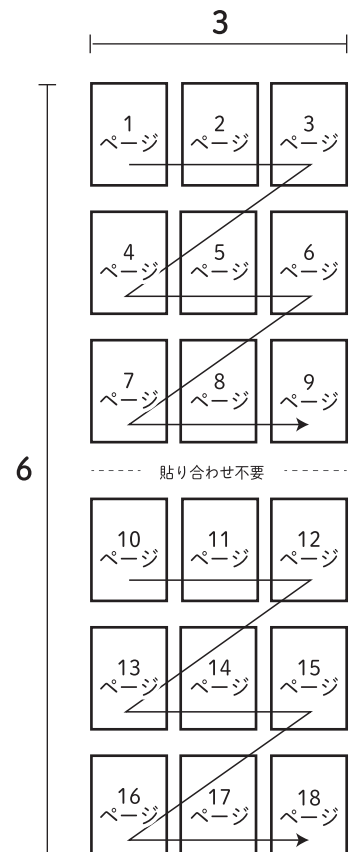
↑

↑

↑

↑

↑

↑

↑

↑

↑

↑

↑

↑

↑

↑

↑

↑

↑

↑

↑

↑

↑

重ねて十字を作る

■この作品のパターンの並べ方

ママとワンコのお揃い服 カーディガン (M) <6×3>

< 6 × 3 >
タテの数 ヨコの数



レディブティック
2023年春号 掲載

ママとワンコのお揃い服
カーディガン

デザイン: 犬服教室ティアン

<Mサイズ>

出来上がりサイズ

バスト112cm

着丈75cm

裁断線: _____

出来上がり線: _____

ノッチ (合印) : †

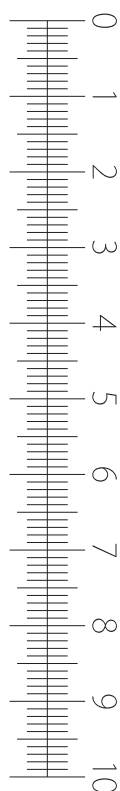

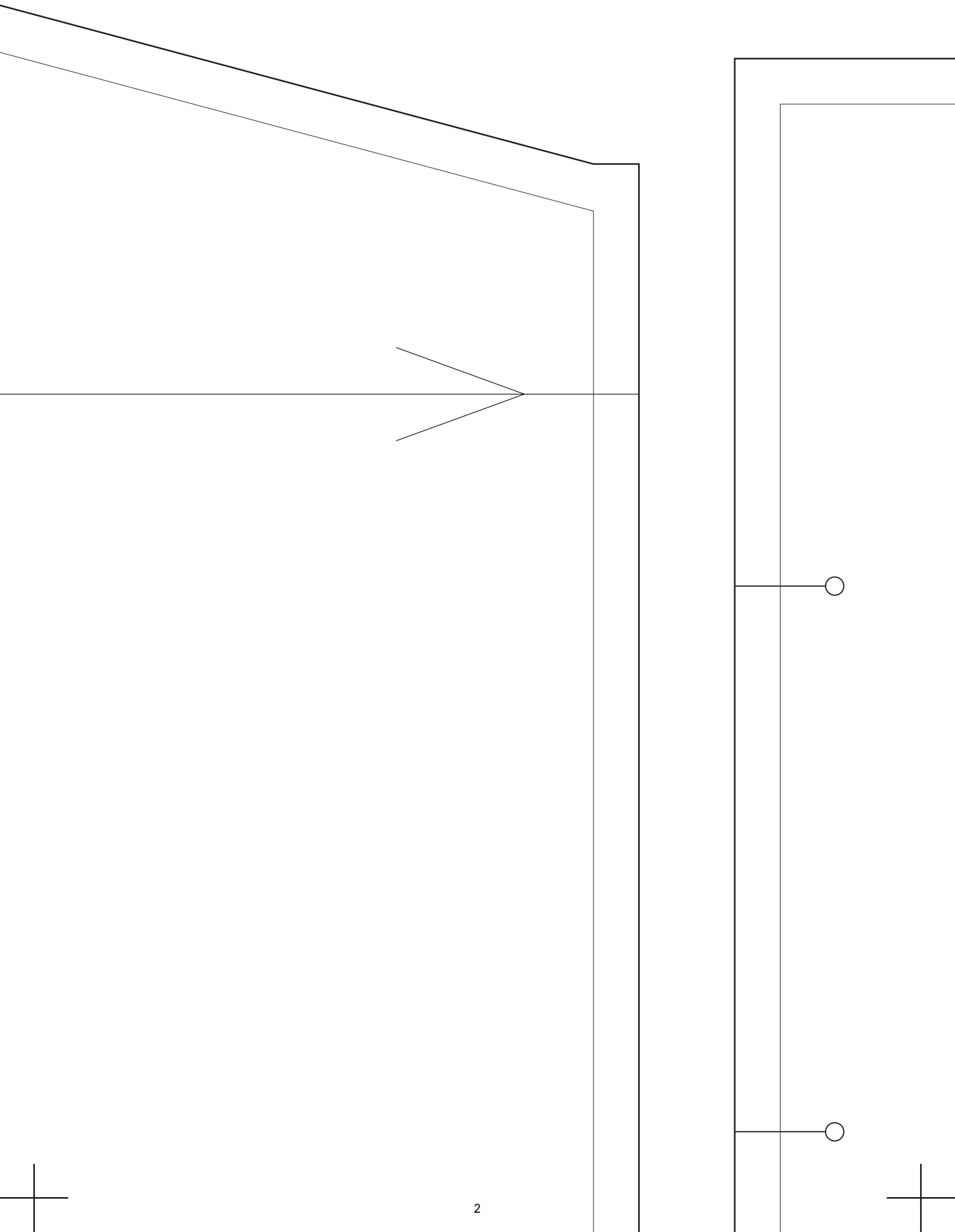

背中/母身

○肩線と合わす

○切替え線と合わす

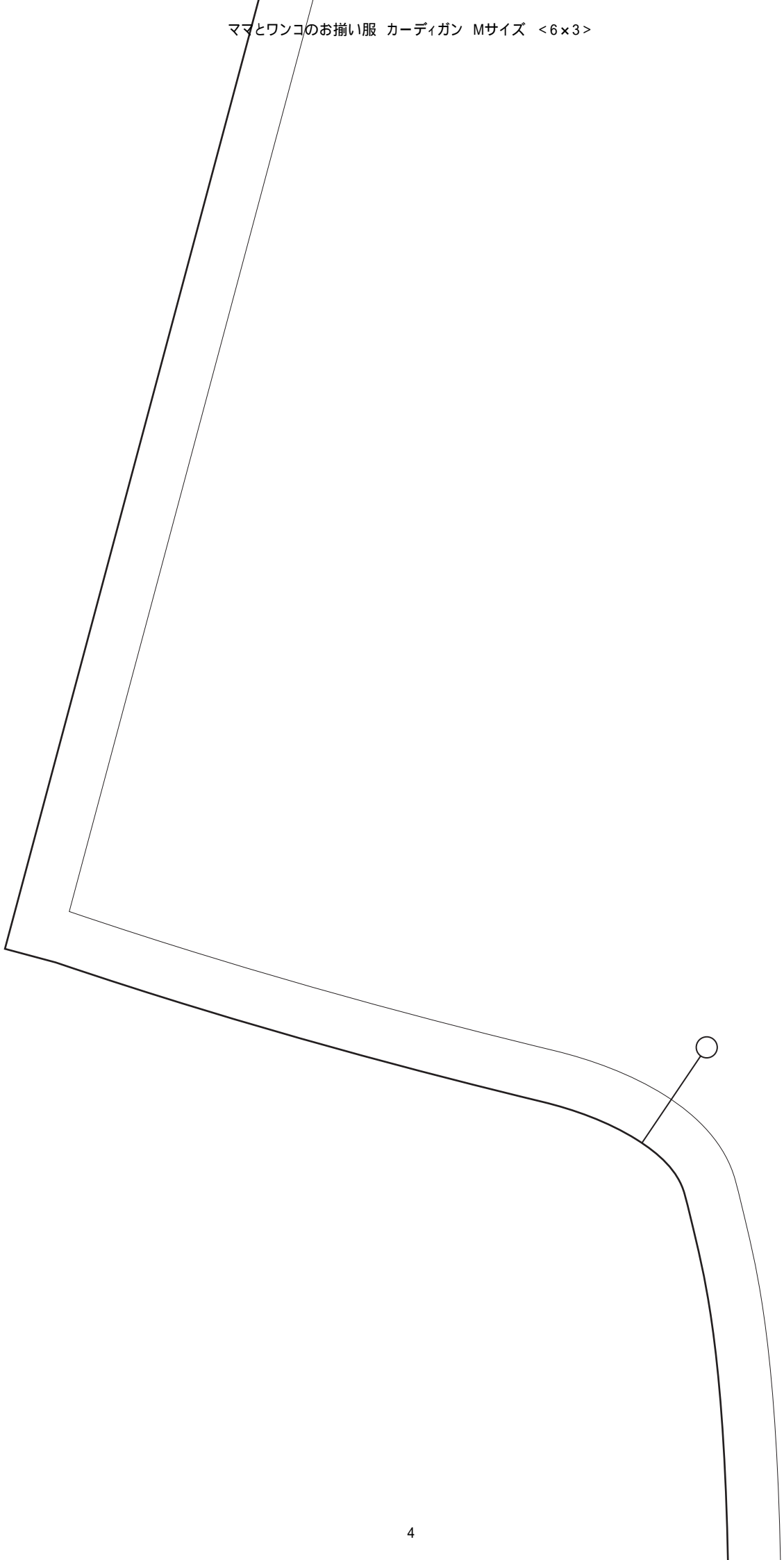

ママとワンコのお揃い服

カーディガン (M)

袖×1枚 (無地)

Copyright ©babylock

ママとワンコのお揃い服

カーディガン (M)

衿×2枚 (無地)

Copyright ©babylock



ママとワンコのお揃い服
カーディガン (M)
袖リブ×2枚 (無地)

Copyright ©babylock

ウエスト

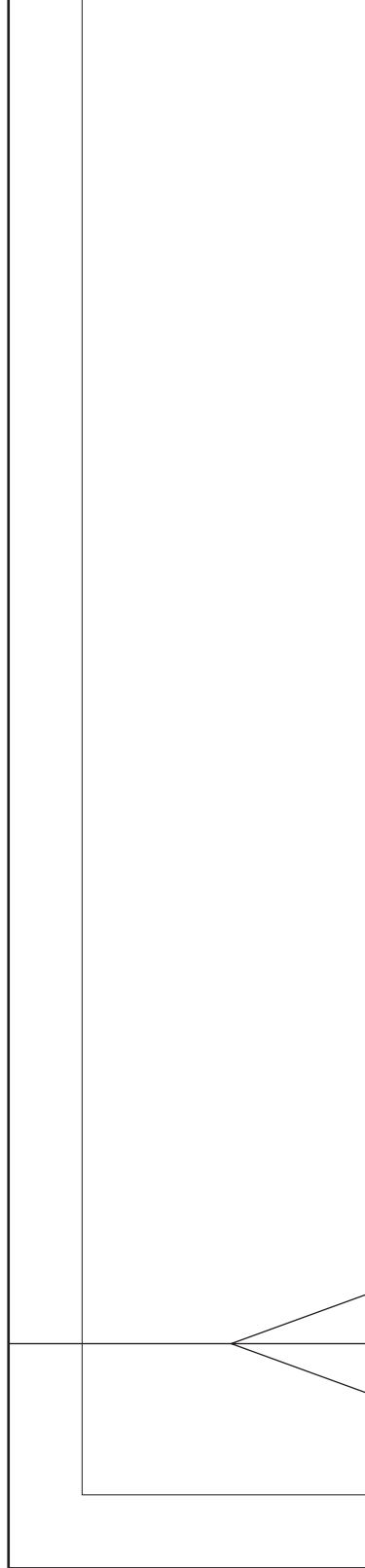
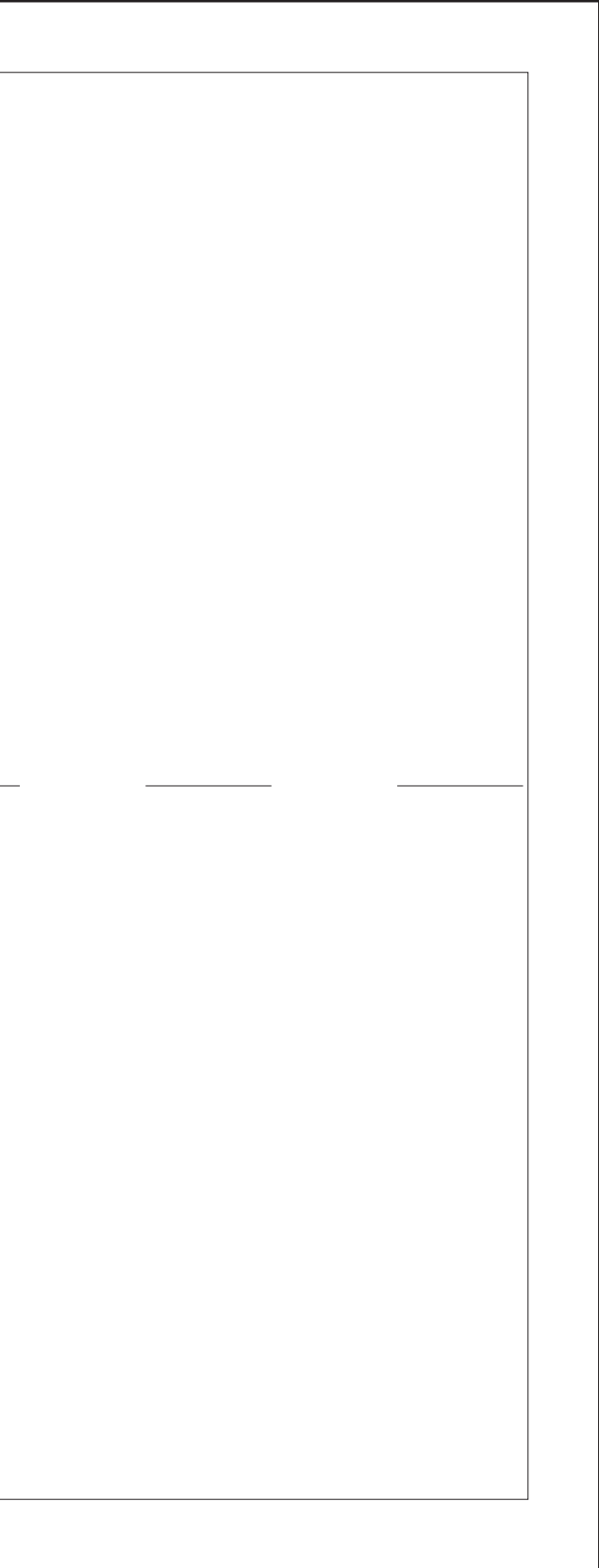

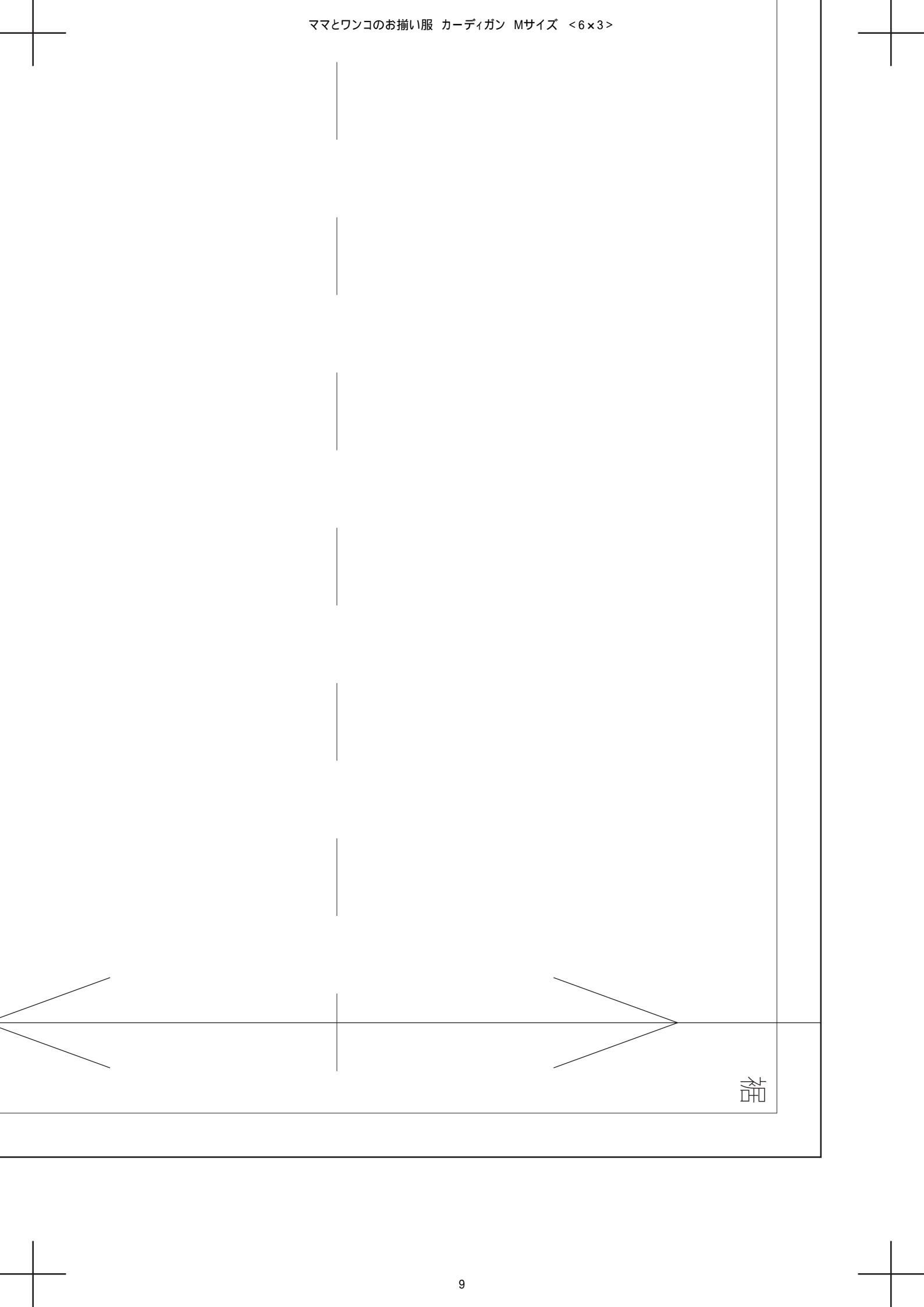

箱

ママとワンコのお揃い服
カーディガン (M)
後身頃×1枚 (ボーダー)

Copyright ©babylock

わ
裁
ち

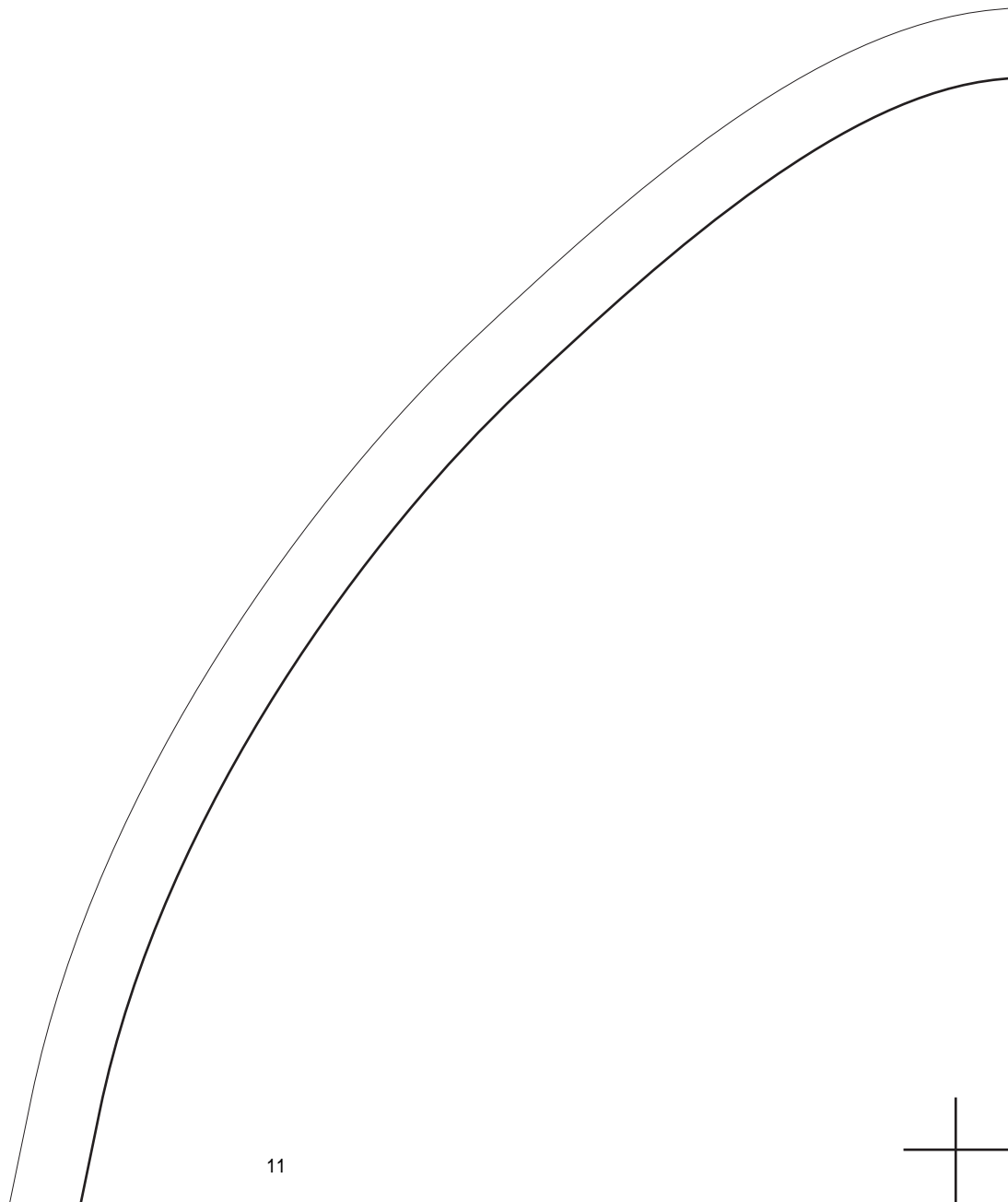
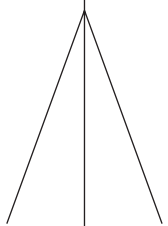

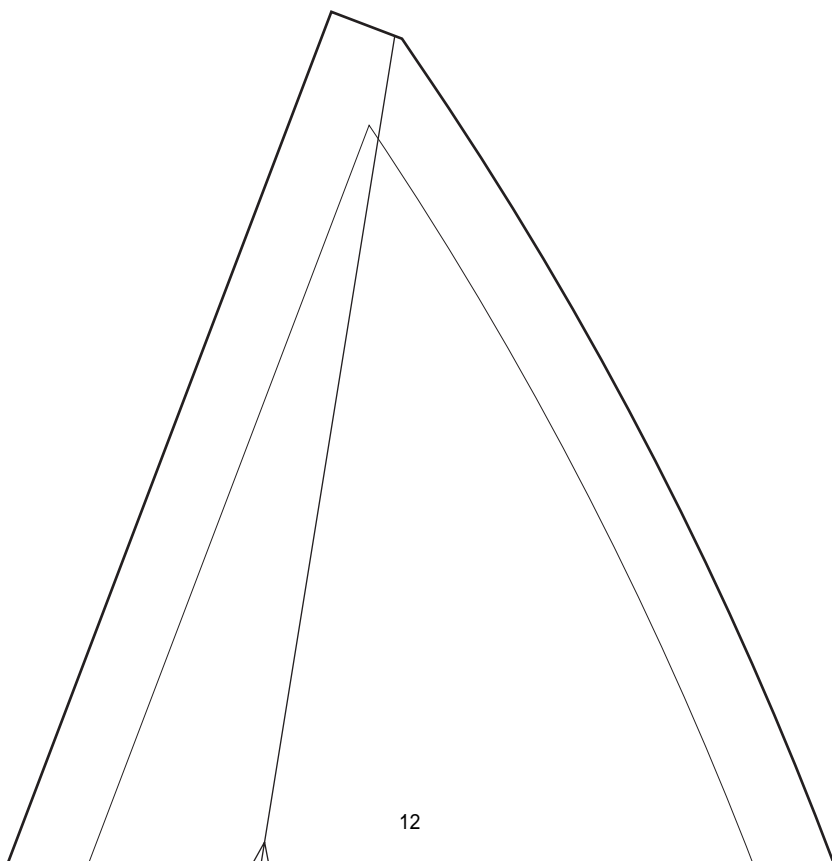
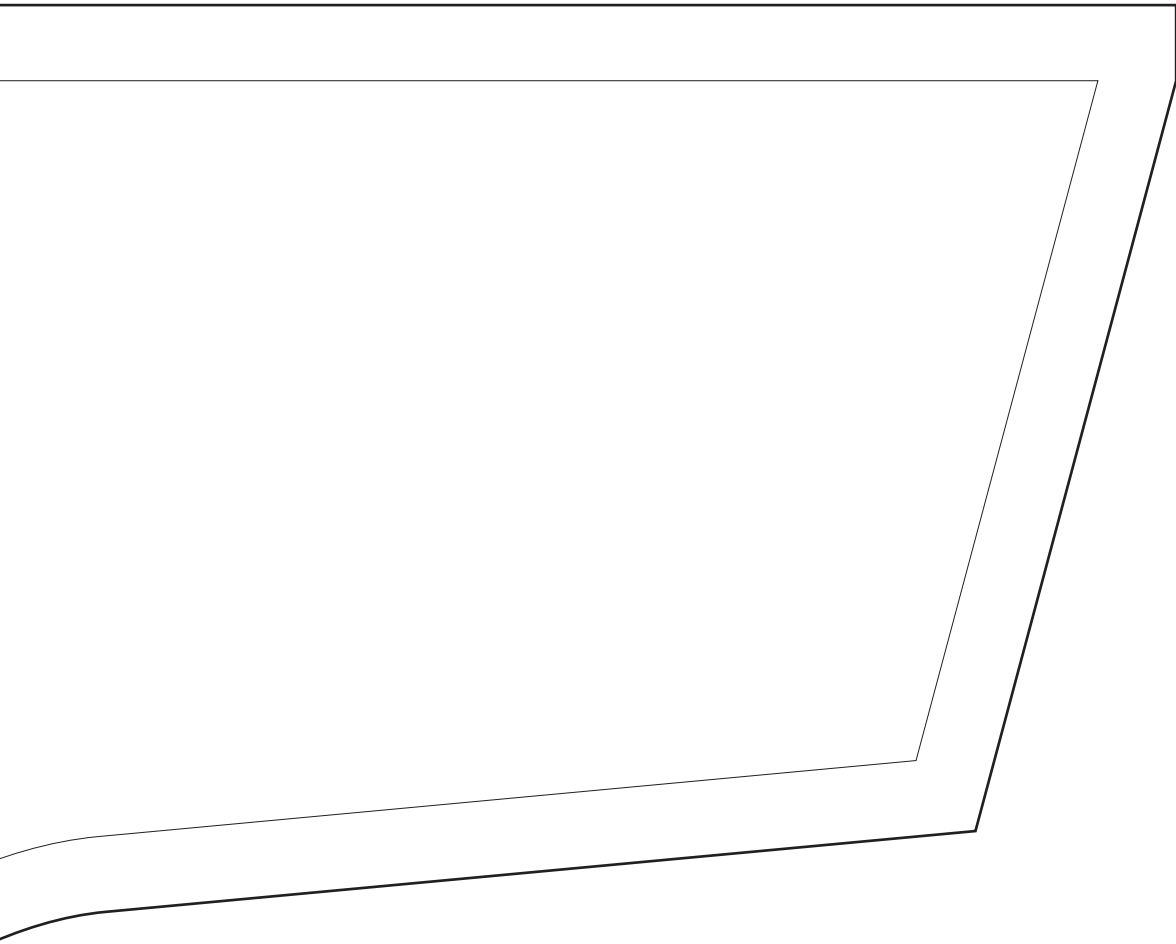

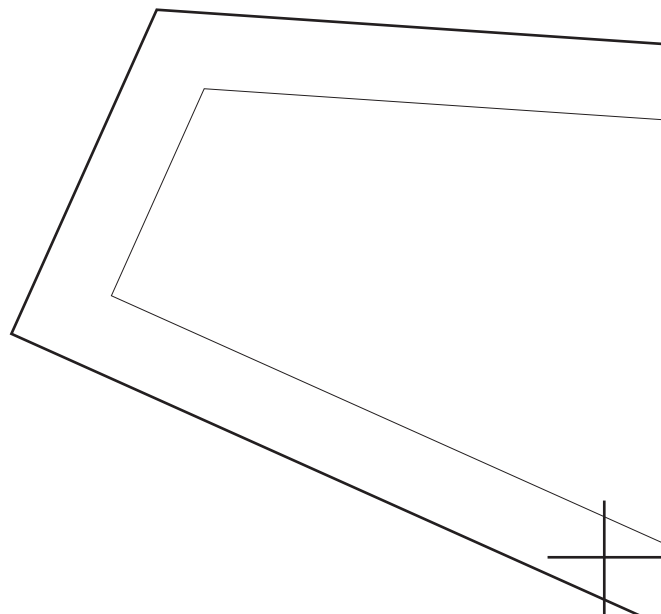

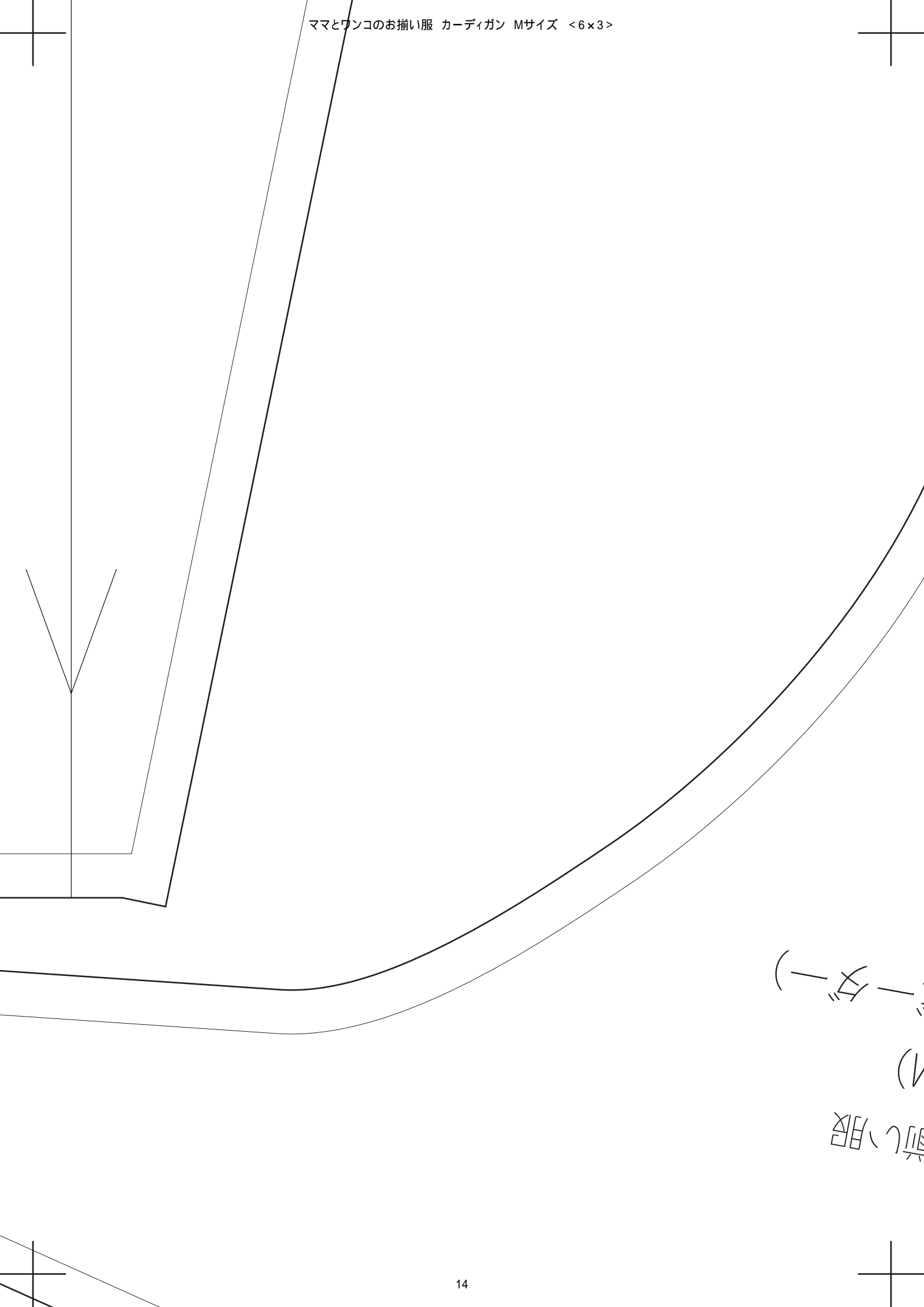

前(左)
袖(右)

Copyright ©babylock

ママとワンコのお揃い服
カーディガン (M)
前身頃×2枚 (赤)

わ
裁
ち

ママとワンコのお揃い服
カーディガン (M)
裾布×1枚 (無地)

Copyright ©babylock

