

【型紙の使い方】

縮小・拡大などせずにA4サイズの紙に必ず「100%」で印刷しましょう。

PDFデータの1ページ目に10cmの定規が印刷されていますので、実寸で印刷されているか必ず確認しましょう。

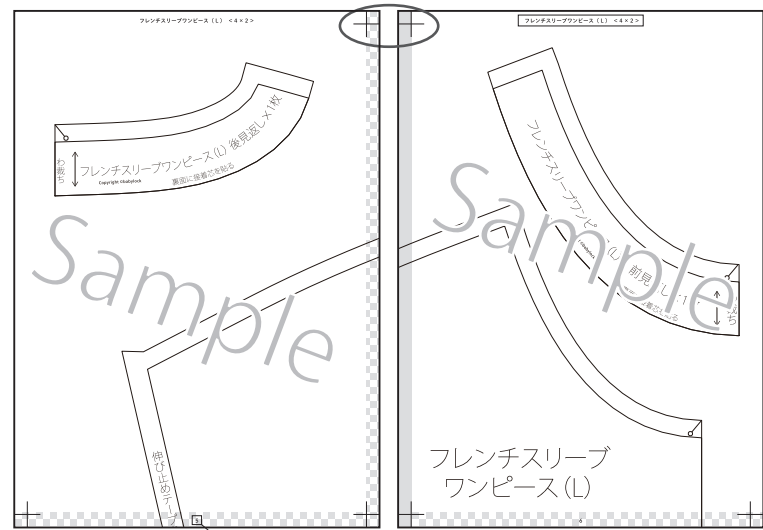
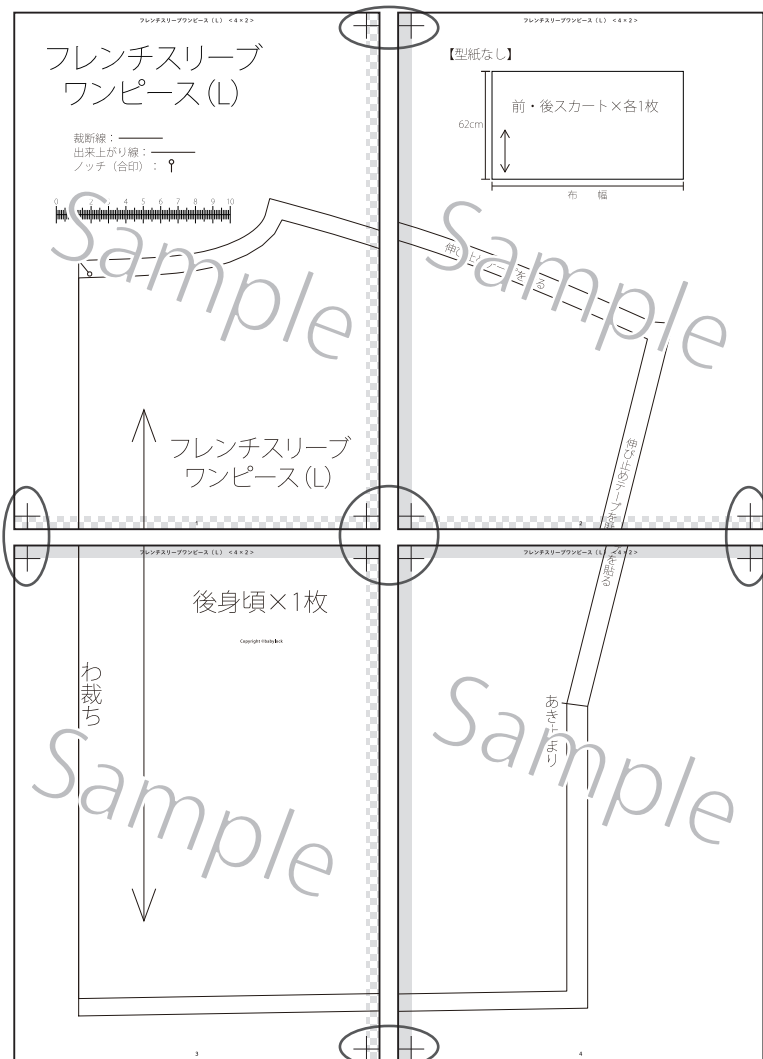

5























ページ番号

◆パターンのつなぎ(貼り)方

- 1、図を参考に余白部分をカットし、角の印を合わせて貼り合わせる。
- 2、裁断線でカットする。

 のりしろ

 余白 (重なると線が見えなくなるのでカットすると良い)

↑

↑

↑

↑

↑

↑

↑

↑

↑

↑

↑

↑

↑

↑

↑

↑

↑

↑

↑

↑

↑

↑

↑

↑

↑

↑

↑

↑

↑

↑

↑

↑

↑

↑

↑

↑

↑

↑

↑

↑

↑

↑

↑

↑

↑

↑

↑

↑

↑

↑

↑

↑

↑

↑

↑

↑

↑

↑

↑

↑

↑

↑

↑

↑

↑

↑

↑

↑

↑

↑

↑

↑

↑

↑

↑

↑

↑

↑

↑

↑

↑

↑

↑

↑

↑

↑

↑

↑

↑

↑

↑

↑

↑

↑

↑

↑

↑

↑

↑

↑

↑

↑

↑

↑

↑

↑

↑

↑

↑

↑

↑

↑

↑

↑

↑

↑

↑

↑

↑

↑

↑

↑

↑

↑

↑

↑

↑

↑

↑

↑

↑

↑

↑

↑

↑

↑

↑

↑

↑

↑

↑

↑

↑

↑

↑

↑

↑

↑

↑

↑

↑

↑

↑

↑

↑

↑

↑

↑

↑

↑

↑

↑

↑

↑

↑

↑

↑

↑

↑

↑

↑

↑

↑

↑

↑

↑

↑

↑

↑

↑

↑

↑

↑

↑

↑

↑

↑

↑

↑

↑

↑

↑

↑

↑

↑

↑

↑

↑

↑

↑

↑

↑

↑

↑

↑

↑

↑

↑

↑

↑

↑

↑

↑

↑

↑

↑

↑

↑

↑

↑

↑

↑

↑

↑

↑

↑

↑

↑

↑

↑

↑

↑

↑

↑

↑

↑

↑

↑

↑

↑

↑

↑

↑

↑

↑

↑

↑

↑

↑

↑

↑

↑

↑

↑

↑

↑

↑

↑

↑

↑

↑

↑

↑

↑

↑

↑

↑

↑

↑

↑

↑

↑

↑

↑

↑

↑

↑

↑

↑

↑

↑

↑

↑

↑

↑

↑

↑

↑

↑

↑

↑

↑

↑

↑

↑

↑

↑

↑

↑

↑

↑

↑

↑

↑

↑

↑

↑

↑

↑

↑

↑

↑

↑

↑

↑

↑

↑

↑

↑

↑

↑

■この作品のパターンの並べ方

ラグランジャケット (Mサイズ) <5×4>

< 5 × 4 >
タテの数 ヨコの数

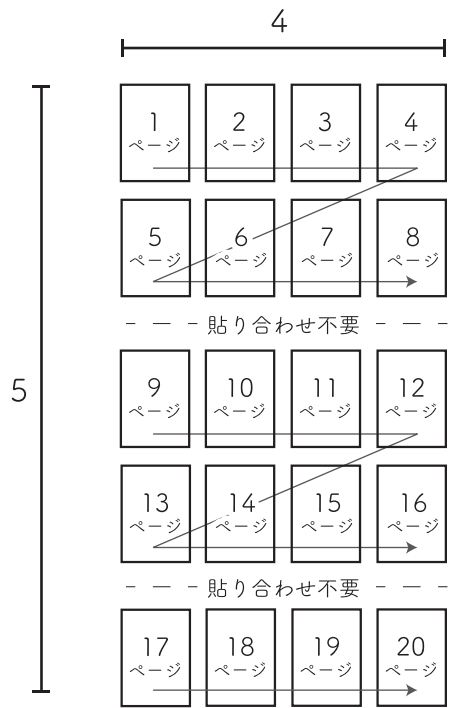

コットンフレンド2024年春号 vol.90 掲載
ラグランスリーブジャケット

デザイン:坂内 鏡子 さん

<Mサイズ>

出来上がりサイズ

総丈:63cm バスト:108cm 衿丈:76cm



裁断線 : —————
出来上がり線 : —————
ノッチ (合印) : ∩

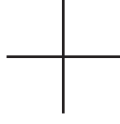
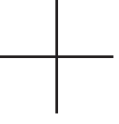

※裾取返し部分の裾幅は裾幅均等設定

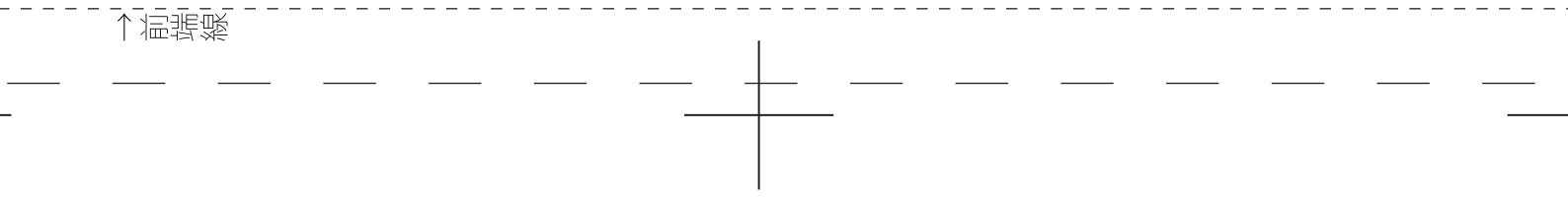

↑裾取返し

裾幅均等設定

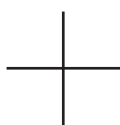
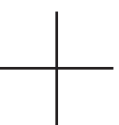

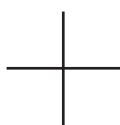
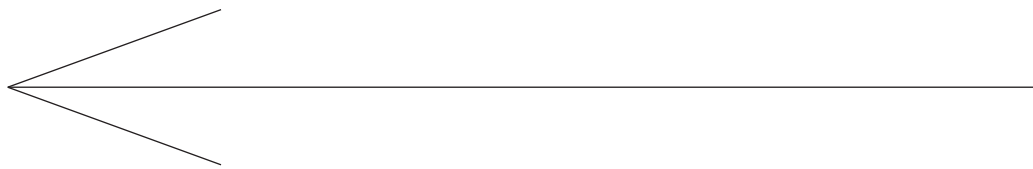
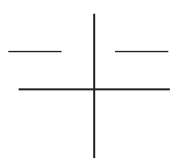
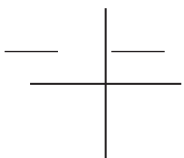
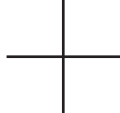

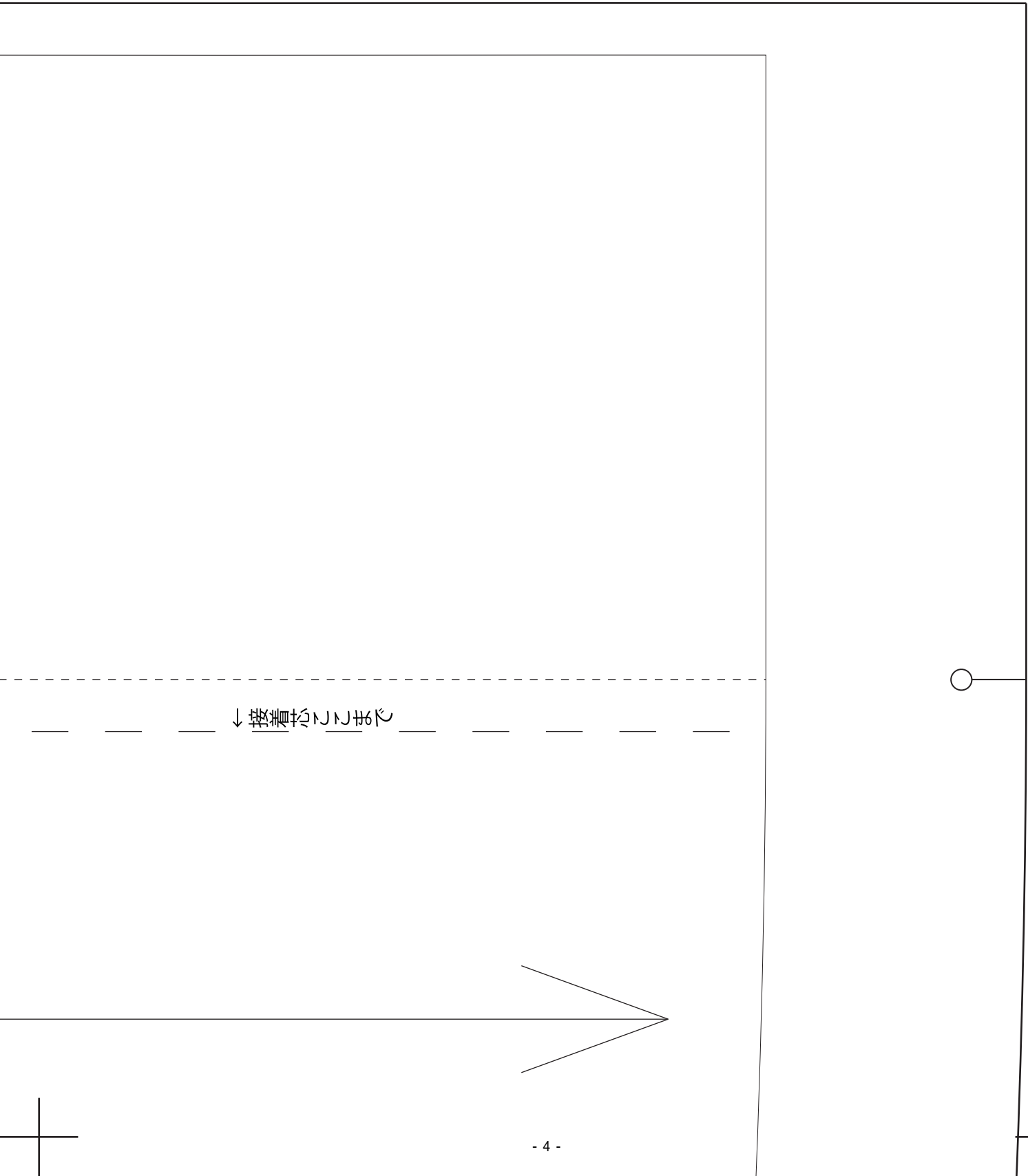

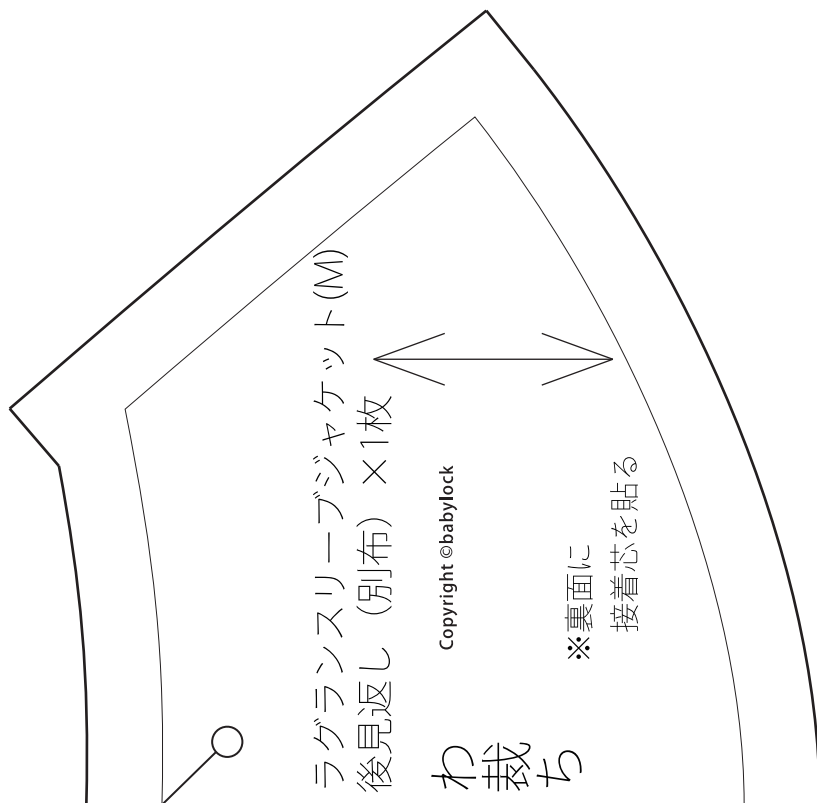

ラグランスリーブジャケット(M)
前身頃 (表布) ×2枚

Copyright ©babylock

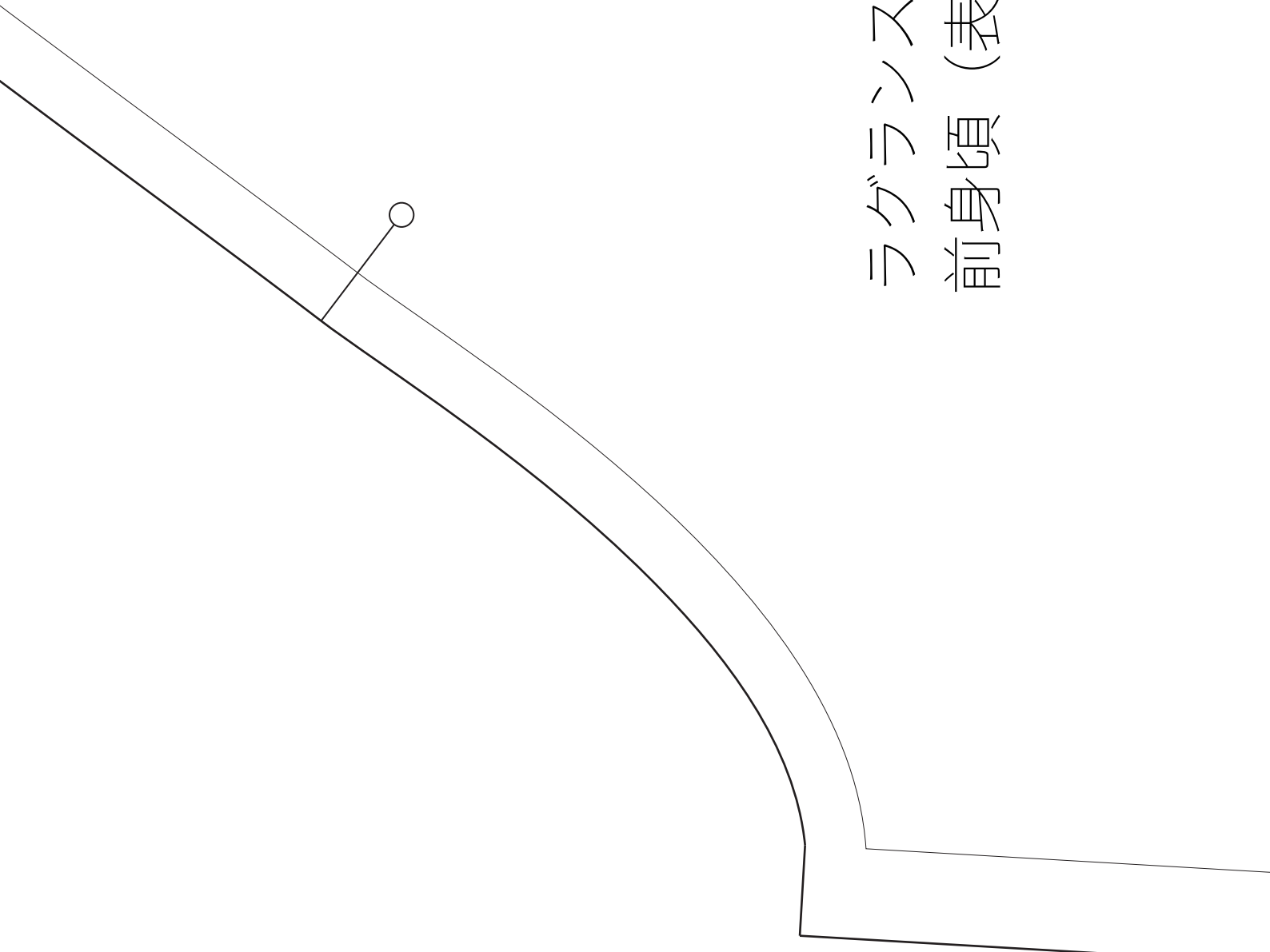

※裏面に直径3cmにカットした
接着芯を貼る

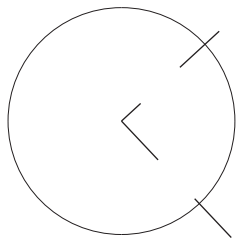

ポケット位置

※裏面に直径3cmにカットした
接着芯を貼る

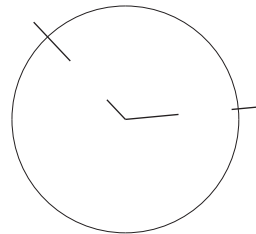

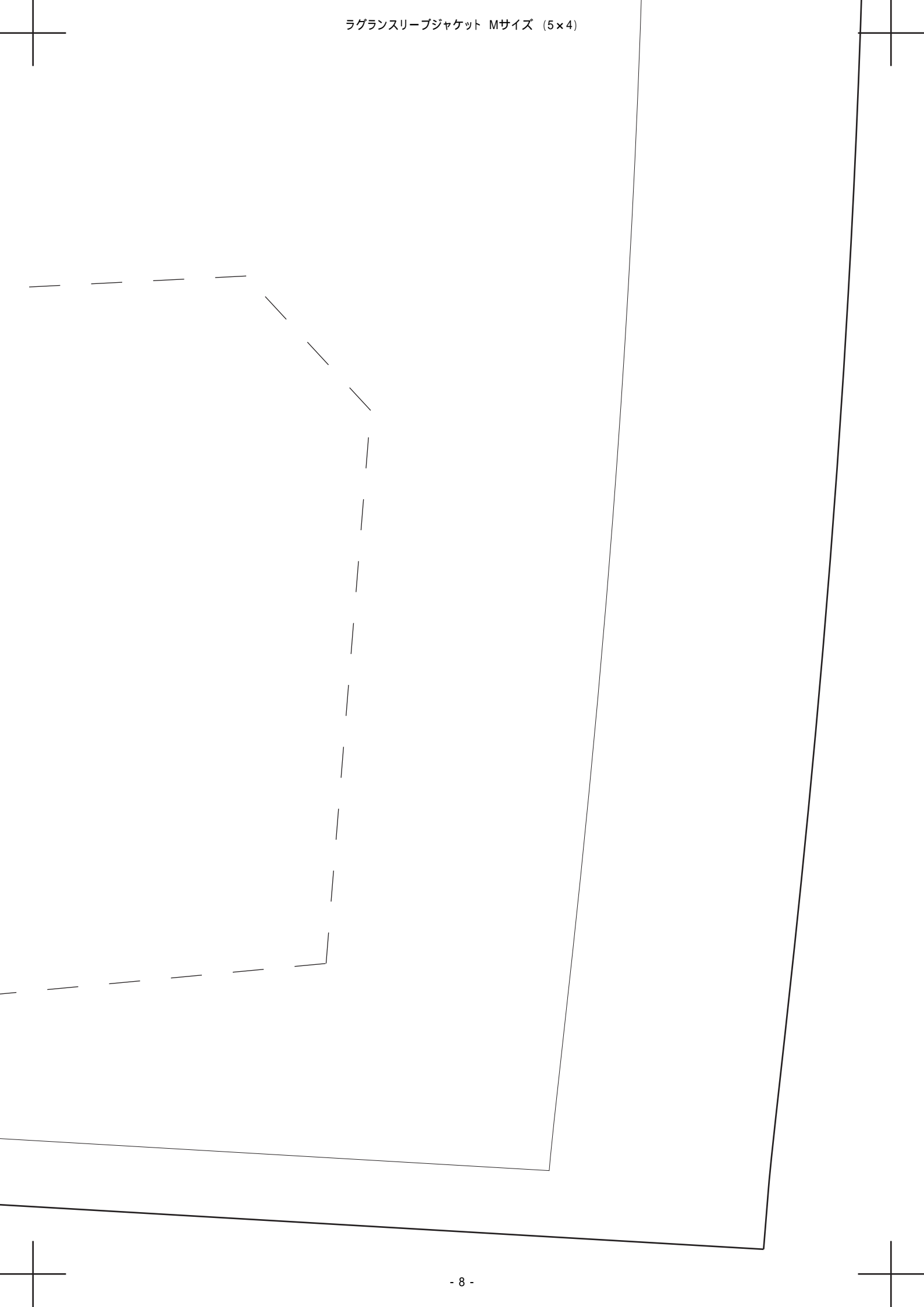

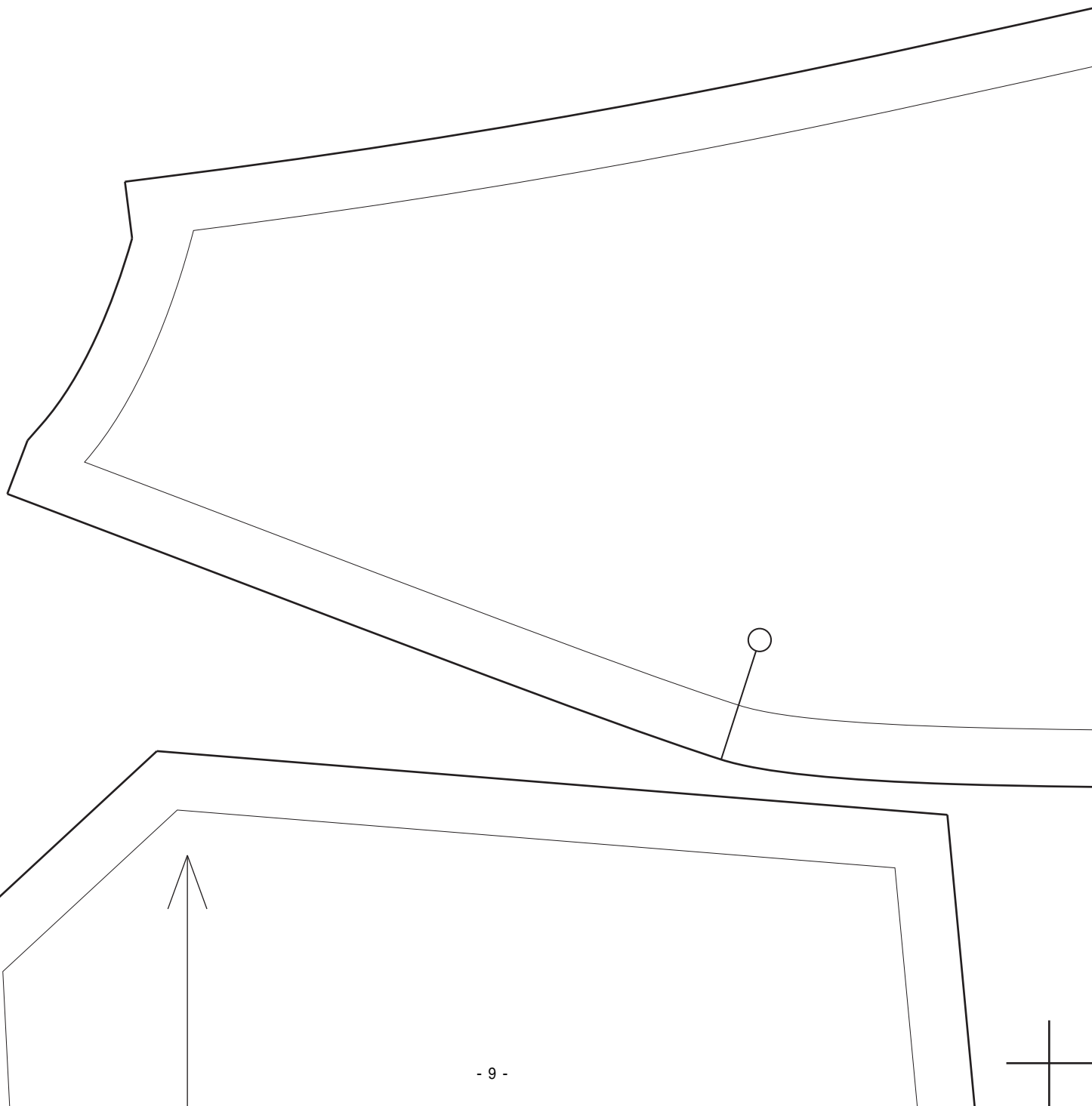

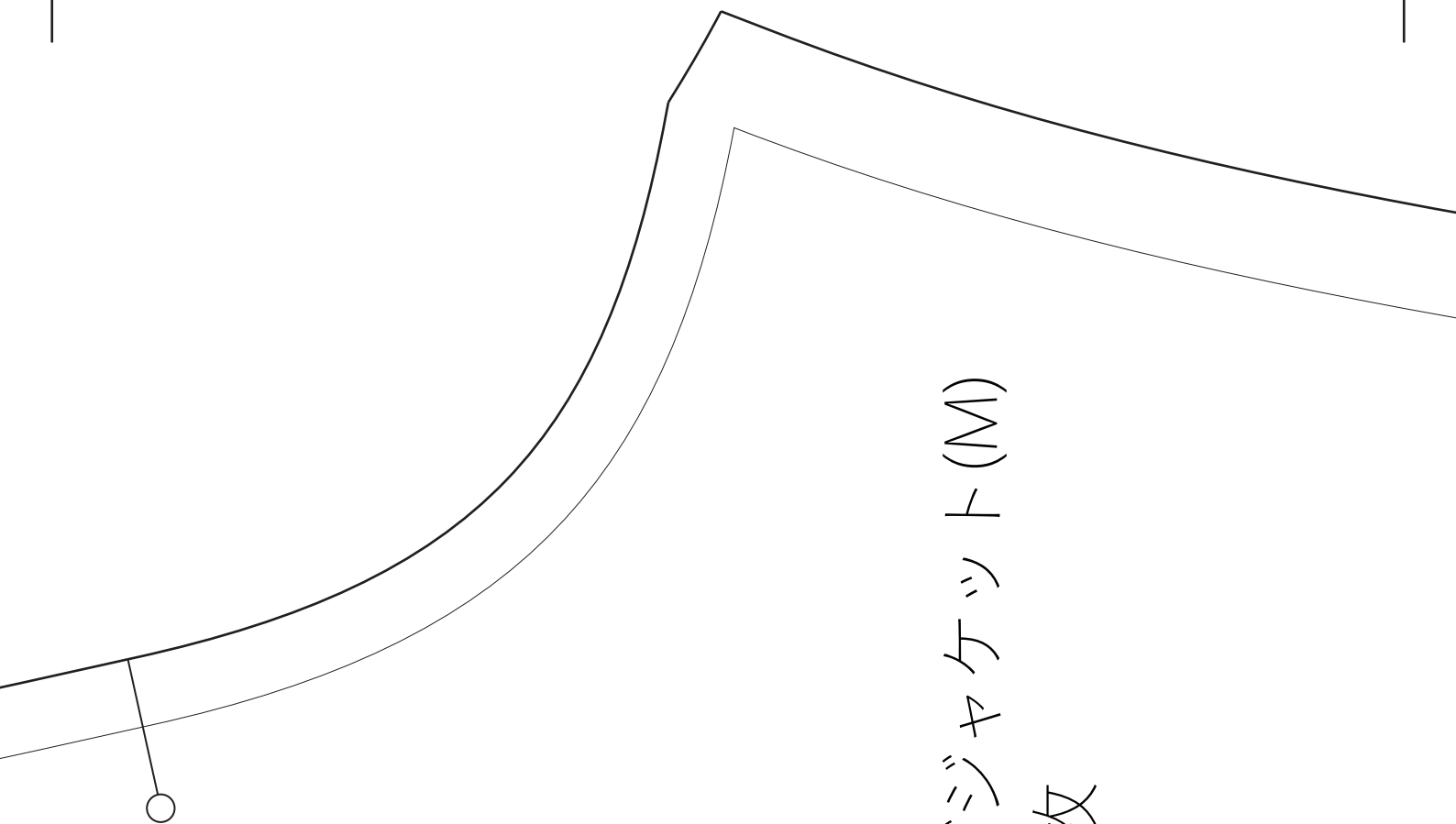

ラグランスリーブジャケット(M)
前袖 (表布) ×2枚

Copyright ©babylock

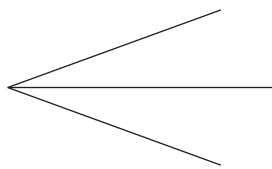

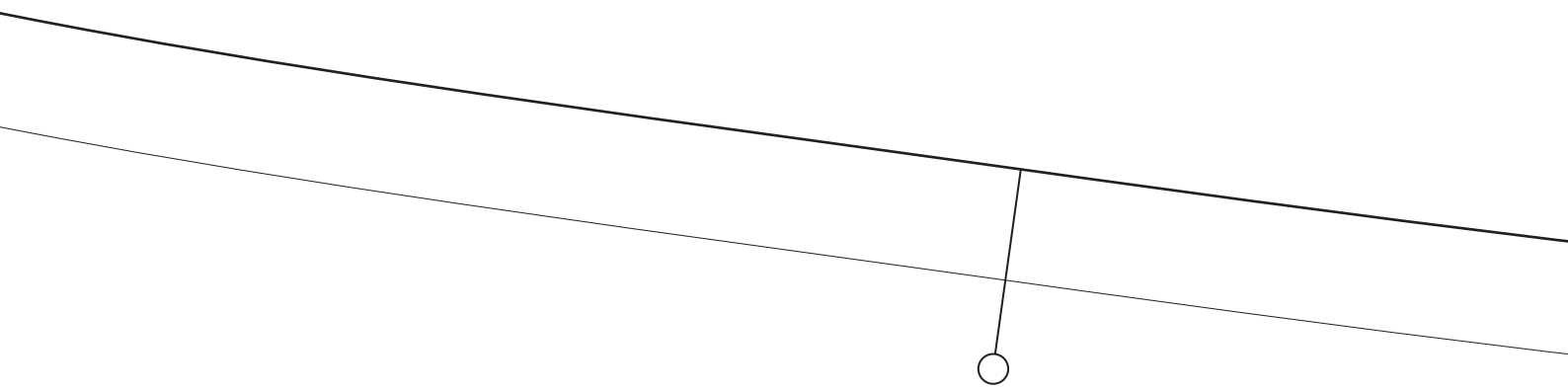

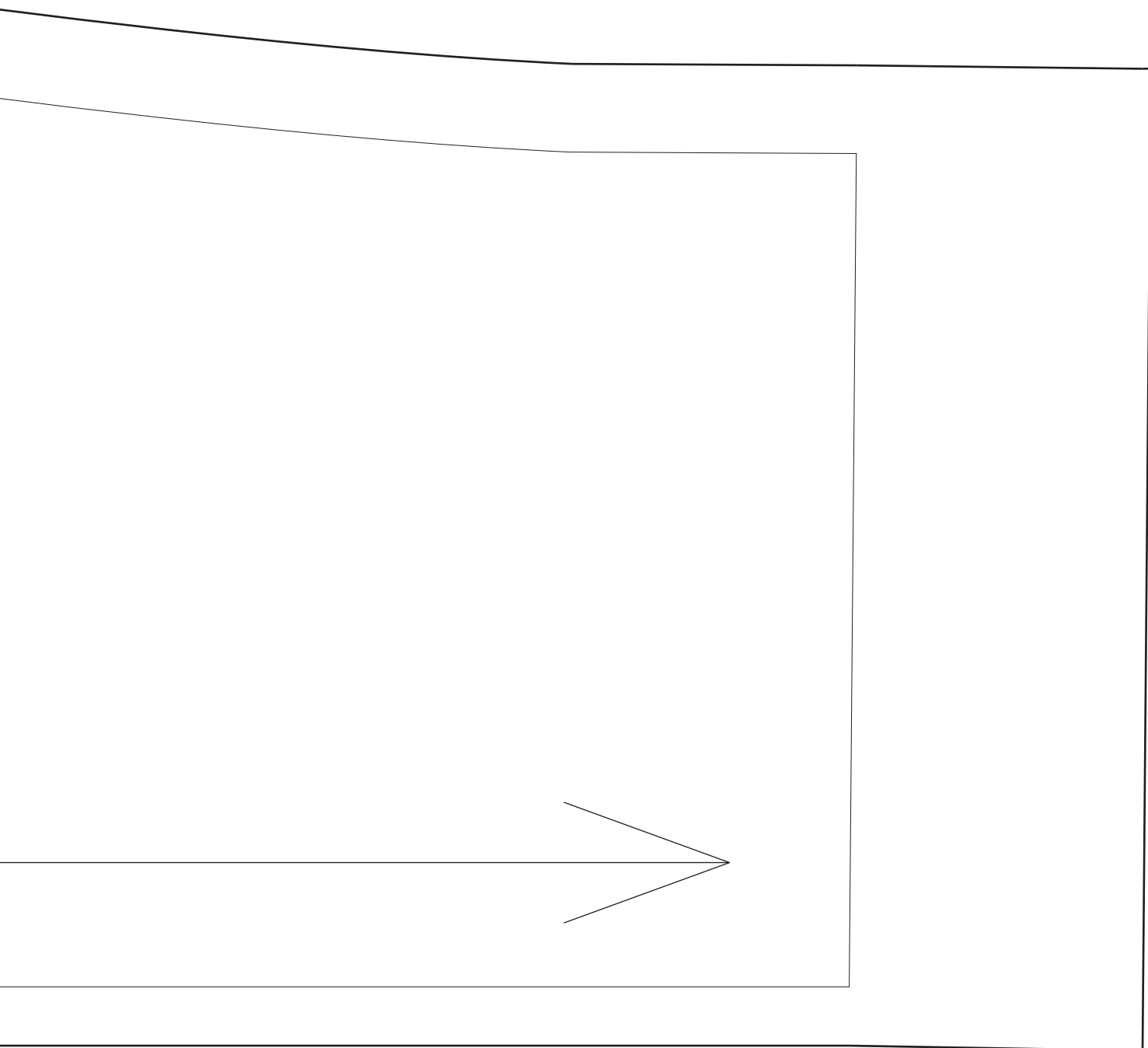

ラグランスリーブジャケット (M)
ポケット (表布) × 2枚



押ひ止めテープを貼る



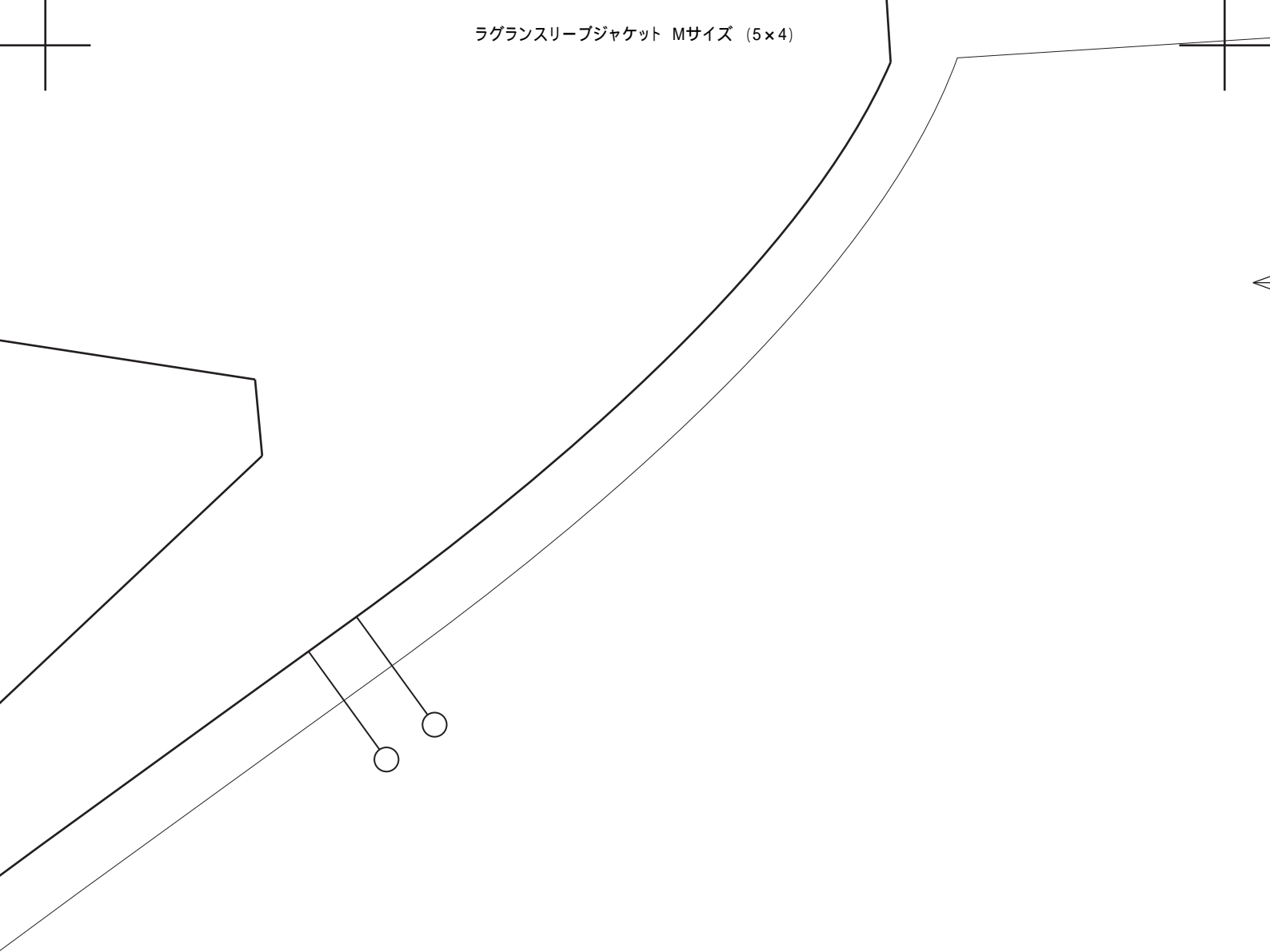

裁ち

ラグランスリーブジャケット(M)
後身頃 (表布) ×1枚

Copyright ©babylock

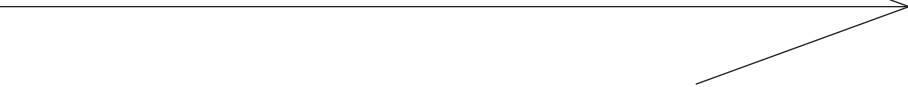

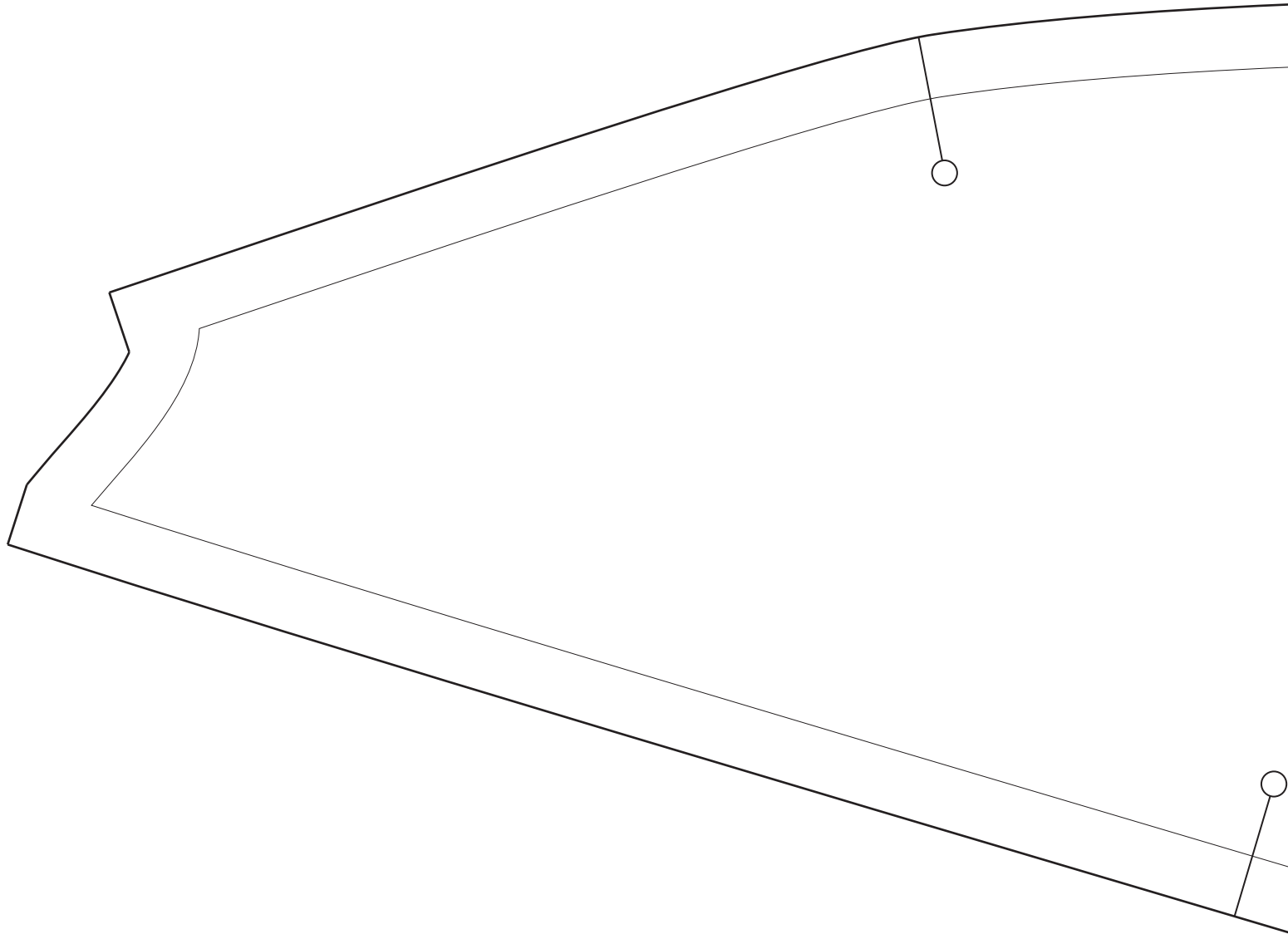

ラグランスリーブジャケット(M)
後袖 (表布) × 2枚

Copyright ©babylock

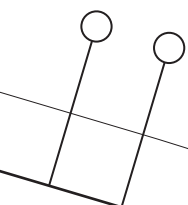
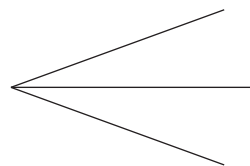

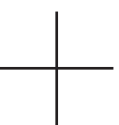
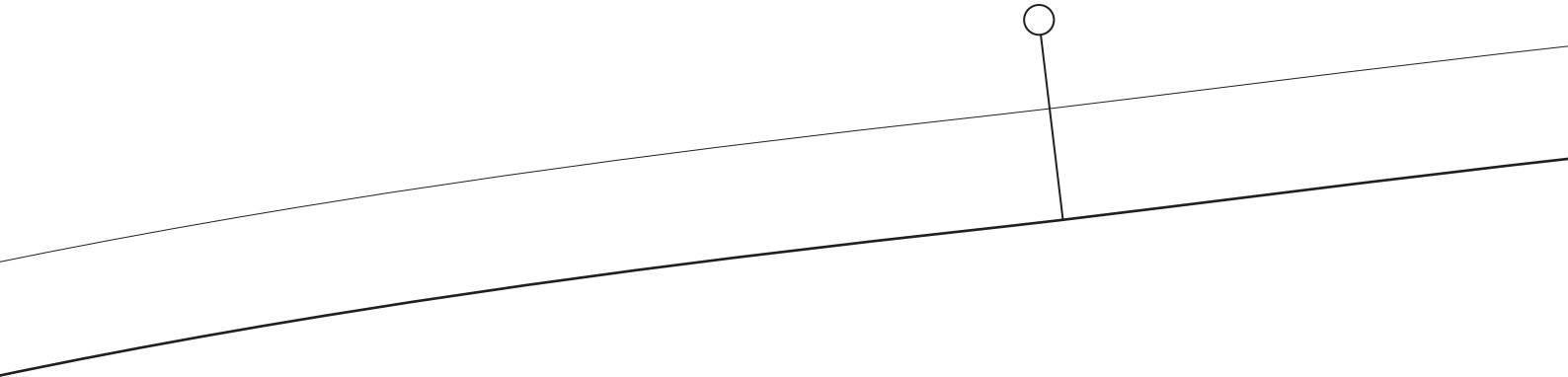
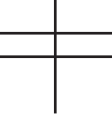

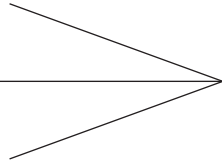

この作品の型紙・作り方レシピの販売・転載、ならびにこれらを用いた完成品の販売を禁じます。